

По вопросам продаж и поддержки обращайтесь:

Архангельск (8182)63-90-72	Краснодар (861)203-40-90	Санкт-Петербург (812)309-46-40
Астана (7172)727-132	Красноярск (391)204-63-61	Саратов (845)249-38-78
Астрахань (8512)99-46-04	Курск (4712)77-13-04	Севастополь (8692)22-31-93
Барнаул (3852)73-04-60	Липецк (4742)52-20-81	Симферополь (3652)67-13-56
Белгород (4722)40-23-64	Магнитогорск (3519)55-03-13	Смоленск (4812)29-41-54
Брянск (4832)59-03-52	Москва (495)268-04-70	Сочи (862)225-72-31
Владивосток (423)249-28-31	Мурманск (8152)59-64-93	Ставрополь (8652)20-65-13
Волгоград (844)278-03-48	Набережные Челны (8552)20-53-41	Сургут (3462)77-98-35
Вологда (8172)26-41-59	Нижний Новгород (831)429-08-12	Тверь (4822)63-31-35
Воронеж (473)204-51-73	Новокузнецк (3843)20-46-81	Томск (3822)98-41-53
Екатеринбург (343)384-55-89	Новосибирск (383)227-86-73	Тула (4872)74-02-29
Иваново (4932)77-34-06	Омск (3812)21-46-40	Тюмень (3452)66-21-18
Ижевск (3412)26-03-58	Орел (4862)44-53-42	Ульяновск (8422)24-23-59
Казань (843)206-01-48	Оренбург (3532)37-68-04	Уфа (347)229-48-12
Калининград (4012)72-03-81	Пенза (8412)22-31-16	Хабаровск (4212)92-98-04
Калуга (4842)92-23-67	Пермь (342)205-81-47	Челябинск (351)202-03-61
Кемерово (3842)65-04-62	Ростов-на-Дону (863)308-18-15	Череповец (8202)49-02-64
Киров (8332)68-02-04	Рязань (4912)46-61-64	Ярославль (4852)69-52-93
	Самара (846)206-03-16	

Единый адрес: rno@nt-rt.ru **Веб-сайт:** www.redlion.nt-rt.ru

Панели оператора Graphite HMIs RED LION. Техническое описание

▶▶▶ Rugged Operator Panels with Modular I/O

The Graphite[®] operator panels are the industry's first rugged HMI touchscreens to combine I/O modules with protocol conversion, data logging, web-based monitoring and IEC 61131 control capabilities.

Available in eight different sizes ranging from 7" to 15", Graphite HMIs feature sleek full-color touchscreens in a streamlined, compact footprint for easy installation. Rugged cast-aluminum construction supports outdoor and indoor display with wide operating temperatures and high shock/vibration tolerances that enable organizations to connect, monitor and control processes regardless of environment. Unify disparate devices by converting up to 20 industrial protocols simultaneously from a built-in library of over 300 supported drivers. In addition, select from a wide variety of module and expansion options to seamlessly extend capabilities and address varying requirements.



INDUSTRY APPLICATIONS

- > Factory Automation
- > Oil & Gas
- > Power & Utilities
- > Maritime
- > Water/Wastewater
- > Plastic Extrusion
- > Data Acquisition
- > Industrial Internet of Things (IIoT)

PRODUCT HIGHLIGHTS

- > Protocol Conversion of over 300+ Drivers
- > Built-In Web Server for Remote Access
- > Real-Time Data Logging to SD Card or via FTP
- > Rugged Construction for Extreme Protection
- > Wide Operating Temperature Range
- > Outdoor Sunlight-Readable Models
- > Scalable Modules and Expansion Options
- > IEC 61131 control capabilities with Crimson Control

FEATURES & BENEFITS

- > Sleek Full-Color HMI Touchscreens
 - 7" to 15" models with narrow tablet-style bezels
 - Outdoor sunlight-readable and widescreen models
- > Versatile Module and Expansion Options
 - Choose from a mix of I/O, PID control or communication to populate up to 8 local module slots*
 - Use Crimson Control module for enhanced IEC 61131 logic control programming
 - Connect Graphite Expansion Racks to easily scale
 - Extend even further with E3 I/O™ high-density modules
- > Rugged Environmental Specifications
 - Wide -20° to 60°C HMI operating temperature
 - High shock and vibration tolerance
 - CE, UL/cUL, UL/cUL Hazardous, ATEX, IECEx and ABS approvals

- > Industry-Leading Protocol Conversion
 - Communicate with over 300 industrial protocols
 - Support up to 20 simultaneous protocols
 - Convert between serial, USB and Ethernet devices
 - Manage multi-vendor environments with ease
- > Powerful Integration Functionality
 - Intuitive Crimson 3.0 software for easy drag-and-drop configuration
 - Ethernet, USB and serial ports make communication simple
 - Built-in data logging enhances troubleshooting and helps meet regulatory requirements
 - Robust web server provides remote access and control to reduce costly site visits

* Model dependent

▶▶▶ Graphite Specifications

COMMUNICATION PROPERTIES

USB Ports

Programming Port: One (1) USB Type B adheres to USB specification 1.1
 Host Ports: Two (2) USB Type A complies with USB specification 2.0
 Supports full-speed data transfers
 Hardware over current protected (0.5 A max per port)

Serial Ports: Format/Baud rates independently configurable

Programming Port: One (1) RS-232 port with RJ12 connector
 Communication Ports:

One (1) RS-232 port via RJ12 connector
 One (1) RS-422/485 port via RJ45 connector

Optional Serial Ports:

One (1) RS-232 port via RJ12 connector
 One (1) RS-422/485 port with via RJ45 connector

Ethernet Ports: 1500 Vrms network isolation

One (1) 10/100Base-T(X) port via RJ45 connector
 Optional Ethernet Port: One (1) 10/100Base-T(X) port via RJ45 connector

POWER INPUT

10 to 30 VDC

Model	Typical	Max	With Modules
G07C	9 W	16 W	37 W
G07S	10 W	17 W	38 W
G09	13 W	20 W	45 W
G10C/R	12 W	19 W	48 W
G10S	18 W	24 W	53 W
G12	16 W	23 W	56 W
G15	20 W	27 W	60 W

Must use a Class 2 circuit according to National Electrical Code (NEC), NFPA-70 or Canadian Electrical Code (CEC), Part I, C22.1 or a Limited Power Supply (LPS) according to IEC 60950-1 or Limited-energy circuit according to IEC 61010-1. Power connection via removable three position terminal block.

Battery: Lithium coin cell
 Typical lifetime of 10 years

POWER CONNECTION

High compression cage-clamp terminal block
 Wire Strip Length: 0.3" (7.5 mm)
 Wire Gauge Capacity: One 14 AWG (1.63 mm) solid,
 two 18 AWG (1.02 mm) or four 20 AWG (0.81 mm)

NETWORK MEDIA

10BaseT: ≥ Cat3 cable
 100BaseTX: ≥ Cat5 cable

ENVIRONMENTAL

Operating Temperature: -20°C to 60°C
 Storage Temperature: -20°C to 70°C
 Operating Humidity: 0 to 85% (non condensing)
 Operating Altitude: Up to 2000 meters
 Shock: 40 g per IEC 68-2-27
 Vibration: 4 g @ 5-500 Hz per IEC 68-2-6

LCD DISPLAY

Touchscreen: Resistive analog

Model	Size	Pixels	Brightness	Backlight
G07C	7 in	800 X 480	500 cd/m ²	50,000 HR TYP.
G07S	7 in	800 X 480	1000 cd/m ²	70,000 HR TYP.
G09	9 in	800 X 480	400 cd/m ²	70,000 HR TYP.
G10C	10 in	640 X 480	450 cd/m ²	70,000 HR TYP.
G10R	10 in	800 X 600	400 cd/m ²	70,000 HR TYP.
G10S	10 in	640 X 480	1500 cd/m ²	35,000 HR TYP.
G12	12 in	1280 X 800	400 cd/m ²	70,000 HR TYP.
G15	15 in	1024 X 768	400 cd/m ²	70,000 HR TYP.

CERTIFICATION & COMPLIANCE

CE Approved

EN 61326-1 Immunity to Industrial Locations Emission CISPR 11 Class A
 IEC/EN 61010-1
 RoHS Compliant

ATEX Approved

II 3 G Ex ic nA IIC T4 Gc
 II 3 D Ex tc IIIC T135°C Dc
 DEMKO 14 ATEX 1387X
 EN 60079-0, -11, -15, -31

IECEx Approved

Ex ic nA IIC T4 Gc
 Ex tc IIIC T135°C Dc
 IECEx UL 15.0035X
 IEC 60079-0, -11, -15, -31

UL Approved

cULus Listed for Ordinary Location: File #E302106
 UL 61010-1, -2-201

cULus Listed for Hazardous Location: File #E317425

Class I, Division 2, Groups A, B, C and D

Class II, Division 2, Groups F and G

Class III, Division 2

ANSI/ISA 12.12.01, C22.2 No. 213-M1987, 157-92

Type 4X Indoor / IP66 Enclosure rating (Face only) for all models Type 4X

Outdoor Enclosure rating (Face only) for GxxSxxxx models

ABS Type Approval for Shipboard Applications

MECHANICAL

Construction: Cast aluminum enclosure with NEMA 4X/IP66 rating for indoor/outdoor use when correctly fitted with the gasket provided.
 Installation Category II, Pollution Degree 2.

Weight:

G07 – 2.26 lb. (1.03 kg)

G09 – 3.39 lb. (1.54 kg)

G10 – 4.80 lb. (2.18 kg)

G12 – 5.06 lb. (2.29 kg)

G15 – 7.73 lb. (3.50 kg)

Specifications are subject to change. Visit www.redlion.net for more information.

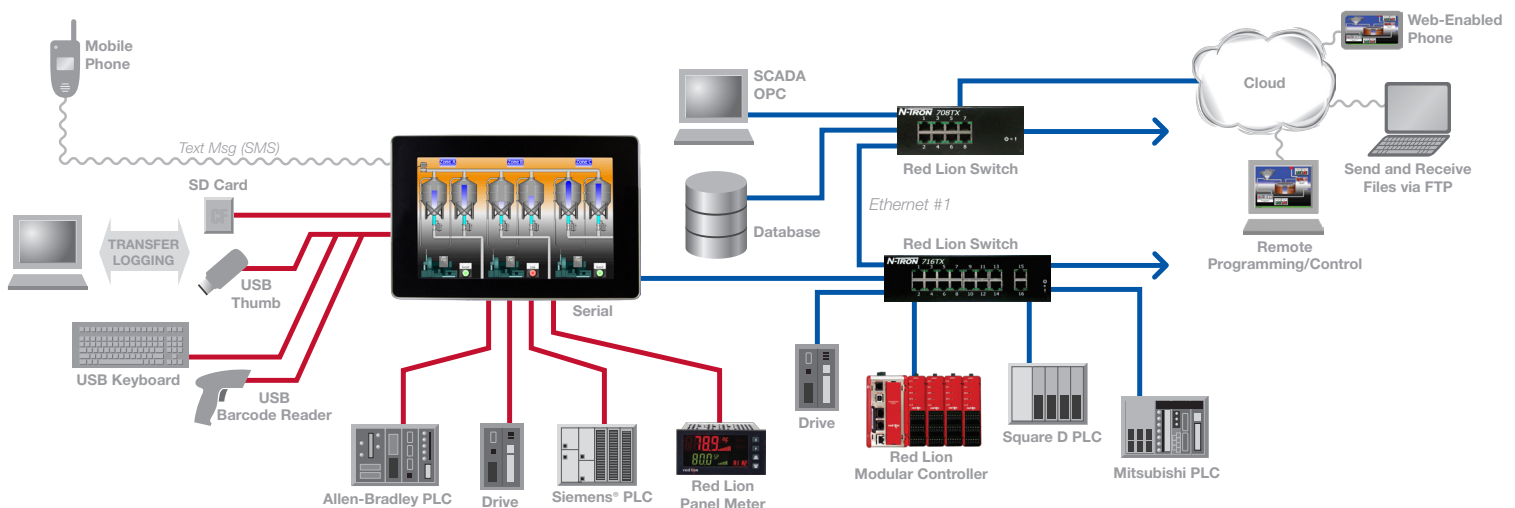

▶▶▶ Graphite Dimensions in Inches (mm)

G07

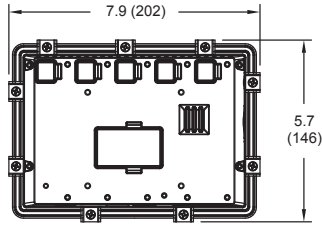
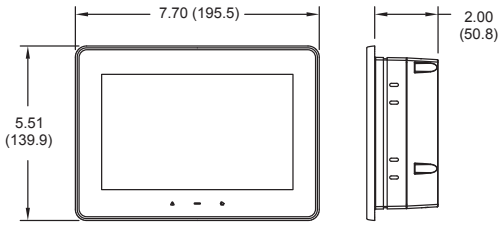

(MOUNTING CLIPS INSTALLED)

G12

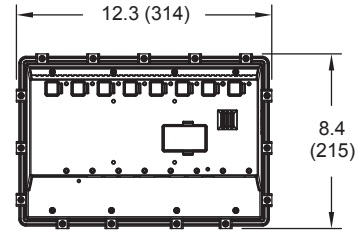
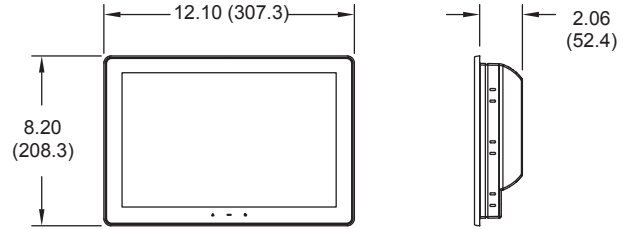

(MOUNTING CLIPS INSTALLED)

G09

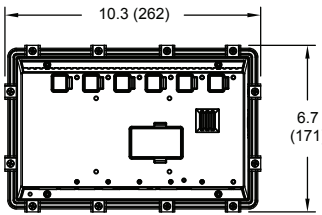
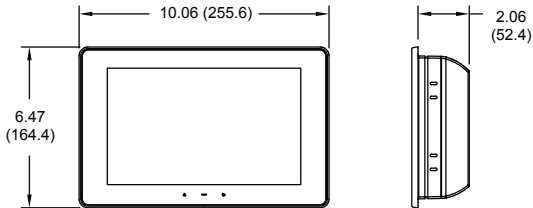

(MOUNTING CLIPS INSTALLED)

G15

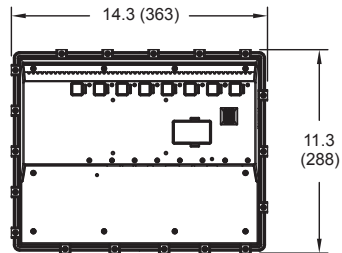
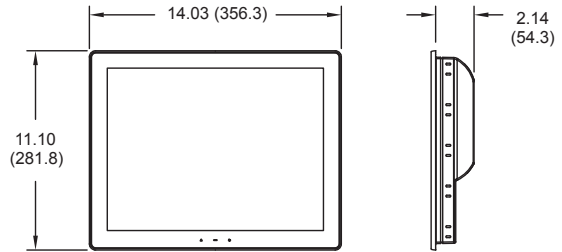

(MOUNTING CLIPS INSTALLED)

G10

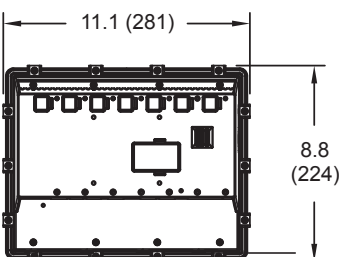
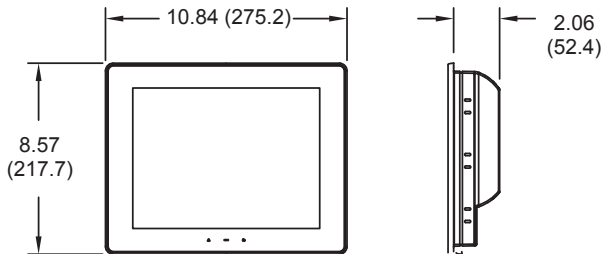

(MOUNTING CLIPS INSTALLED)

▶▶▶ Graphite Ordering Guide

GRAPHITE OPERATOR PANELS

MODEL NUMBER	DESCRIPTION
G07C0000	7" Operator Interface Terminal for Indoor Use
G07S0000	7" Operator Interface Terminal for Outdoor Use
G09C0000	9" Operator Interface Terminal for Indoor Use
G09C1000	9" Operator Interface Terminal for Indoor Use
G10C0000	10" Operator Interface Terminal for Indoor Use
G10C1000	10" Operator Interface Terminal for Indoor Use
G10S0000	10" Operator Interface Terminal for Outdoor Use
G10S0000	10" Operator Interface Terminal for Outdoor Use
G10R0000	10" Operator Interface Terminal, High Resolution Display for Indoor Use
G10R0000	10" Operator Interface Terminal, High Resolution Display for Indoor Use
G12C0000	12" Operator Interface Terminal for Indoor Use
G12C1100	12" Operator Interface Terminal with Aux. Ethernet and dual RS485 ports
G15C0000	15" Operator Interface Terminal for Indoor Use
G15C1100	15" Operator Interface Terminal with Aux. Ethernet and dual RS485 ports

CRIMSON CONTROL MODULE

MODEL NUMBER	DESCRIPTION
GMCC0000	Graphite Module, enables IEC 61131 control capabilities via Crimson Control

PID CONTROL MODULES

MODEL NUMBER	DESCRIPTION
GMP1RA00*	Graphite Module, Single PID, Relay and Analog Outputs
GMP1RM00*	Graphite Module, Single PID, Relay Outputs, Heater Current Monitor
GMP1SA00	Graphite Module, Single PID, SSR and Analog Outputs
GMP1SM00	Graphite Module, Single PID, SSR Outputs, Heater Current Monitor
GMP2R000*	Graphite Module, Dual PID, Relay Outputs
GMP2RM00*	Graphite Module, Dual PID, Relay Outputs and Heater Current Monitor
GMP2S000	Graphite Module, Dual PID, SSR Outputs
GMP2SM00	Graphite Module, Dual PID, SSR Outputs and Heater Current Monitor

DATA ACQUISITION MODULES

MODEL NUMBER	DESCRIPTION
GMDIOR00*	Graphite Module, Digital I/O, 8 Inputs and 6 Relays Outputs
GMDIOS00	Graphite Module, Digital I/O, 8 Inputs and 6 Solid State Outputs
GMUIN400	Graphite Module, 4 Universal Analog Inputs
GMOUT400	Graphite Module, 4 Analog Outputs
GMINI800	Graphite Module, 8 DC Current Inputs
GMINV800	Graphite Module, 8 DC Voltage Inputs
GMTC8000	Graphite Module, 8 Thermocouple Inputs
GMRTD600	Graphite Module, 6 RTD Inputs
GMSG10R0*	Graphite Module, 1 Strain Gage Input, Relay Output
GMSG10S0*	Graphite Module, 1 Strain Gage Input, SSR Output
GMSG11R0*	Graphite Module, 2 Strain Gage Input, Relay Output
GMSG11S0*	Graphite Module, 2 Strain Gage Input, SSR Output

COMMUNICATION MODULES

MODEL NUMBER	DESCRIPTION
GMCAN000*	Graphite Module, CAN Protocol Interface
GMJ19390*	Graphite Module, J1939 Protocol Interface
GMDN0000*	Graphite Module, DeviceNet Protocol Interface
GMPBDP00*	Graphite Module, PROFIBUS DP Protocol Interface
GMHSPA00*	Graphite Module, HSPA+ Cellular

EXPANSION RACKS

MODEL NUMBER	DESCRIPTION
GEXRACK1	Graphite Wide Expansion Rack for Modules
GEXRACK2	Graphite Standard Expansion Rack for Modules
CBLUSBM0	USB Tethering Cable, 0.5 M Metal Jacketed
CBLUSBM1	USB Tethering Cable, 1 M Metal Jacketed
CBLUSBM2	USB Tethering Cable, 2 M Metal Jacketed

* Non ATEX approved modules



BUILD THE PERFECT HMI SOLUTION.

With up to eight available plug-and-play module slots and additional expansion rack options, Graphite HMIs provide a scalable all-in-one platform to help integrate complex multi-vendor environments. Employing modules to address PID control, data acquisition and communication, Graphite HMIs allow users to connect, monitor and control a wide array of equipment to meet specific application requirements. In addition, our Crimson Control module enables users to leverage industry-standard IEC 61131 programming languages such as Ladder Logic, Function Block, Structured Text and Instruction List to develop logic code much like a Programmable Logic Controller (PLC) or Remote Telemetry Unit (RTU) without the added expense.



Connect. Monitor. Control.

По вопросам продаж и поддержки обращайтесь:

Архангельск (8182)63-90-72	Краснодар (861)203-40-90	Санкт-Петербург (812)309-46-40
Астана (7172)727-132	Красноярск (391)204-63-61	Саратов (845)249-38-78
Астрахань (8512)99-46-04	Курск (4712)77-13-04	Севастополь (8692)22-31-93
Барнаул (3852)73-04-60	Липецк (4742)52-20-81	Симферополь (3652)67-13-56
Белгород (4722)40-23-64	Магнитогорск (3519)55-03-13	Смоленск (4812)29-41-54
Брянск (4832)59-03-52	Москва (495)268-04-70	Сочи (862)225-72-31
Владивосток (423)249-28-31	Мурманск (8152)59-64-93	Ставрополь (8652)20-65-13
Волгоград (844)278-03-48	Набережные Челны (8552)20-53-41	Сургут (3462)77-98-35
Вологда (8172)26-41-59	Нижний Новгород (831)429-08-12	Тверь (4822)63-31-35
Воронеж (473)204-51-73	Новокузнецк (3843)20-46-81	Томск (3822)98-41-53
Екатеринбург (343)384-55-89	Новосибирск (383)227-86-73	Тула (4872)74-02-29
Иваново (4932)77-34-06	Омск (3812)21-46-40	Тюмень (3452)66-21-18
Ижевск (3412)26-03-58	Орел (4862)44-53-42	Ульяновск (8422)24-23-59
Казань (843)206-01-48	Оренбург (3532)37-68-04	Уфа (347)229-48-12
Калининград (4012)72-03-81	Пенза (8412)22-31-16	Хабаровск (4212)92-98-04
Калуга (4842)92-23-67	Пермь (342)205-81-47	Челябинск (351)202-03-61
Кемерово (3842)65-04-62	Ростов-на-Дону (863)308-18-15	Череповец (8202)49-02-64
Киров (8332)68-02-04	Рязань (4912)46-61-64	Ярославль (4852)69-52-93
	Самара (846)206-03-16	

Единый адрес: rno@nt-rt.ru **Веб-сайт:** www.redlion.nt-rt.ru